

# USE MANUAL

english

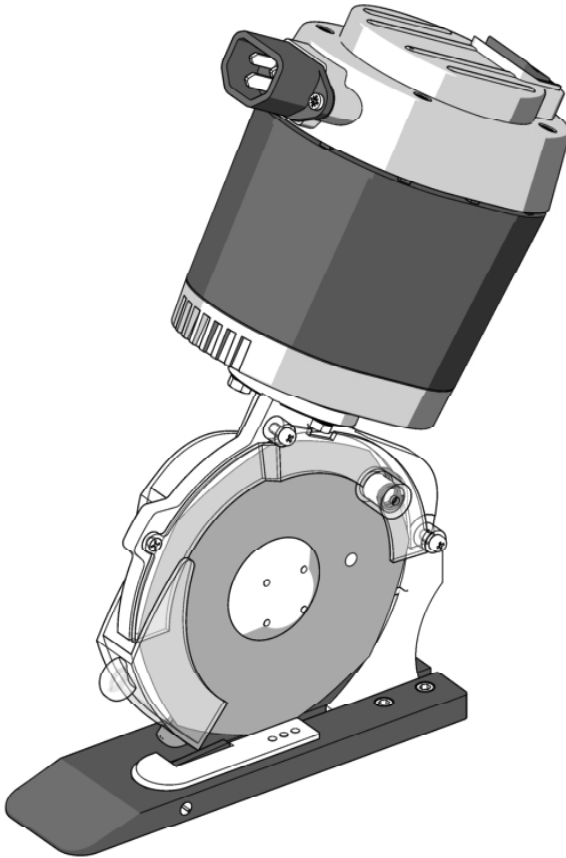

**CUTTING UNIT  
MOD. SW12SM**



dal 1946

ED.1-11/13

Rasor® Elettromeccanica S.r.l. was established in Milan in 1946 by Luigi Spinelli. For more than sixty years it has been producing automatic cutting systems, cutting units for textile applications and electric and pneumatic cutters.



Initially considered as a point of reference for cutting systems in the textile applications, the Rasor® products are nowadays widely used in other fields: chemical, automotive, nautical and sport sectors and in furniture manufacturing.

Rasor® can rely on the professional continuity of three generations, thanks to the precious support of the promoting partner, to his passion, dedication and great experience of seventy years.

The main characteristic of Rasor® is that each working phase, starting from the manufacturing of the product up to its packing and delivery is carried out in Rasor® premises by qualified operators who have professionally grown up following the spirit of the company and of its founders. This ensures the high quality which Rasor® has always considered as essential since the beginning of its activity.

Following the innovative spirit mentioned above, our company is constantly focused on the improvement of the product quality, on the study and development of new materials and technologies.

## ACKNOWLEDGEMENT

Dear Customer,

thank you for choosing a Rasor® Elettromeccanica S.r.l. product.

Rasor® has been a reference point in the field of cutting systems in the textile, clothing, furniture, tailoring, sport, chemical, automotive, nautical and insulating material sectors for years. Its production has been always synonymous with reliability attested by many of satisfied customers.

Rasor® quality system supervises all the company activities in order to provide the Customer with a service that meets its needs and expectations in terms of product quality, delivery reliability and stock of finished products.

All the parts of the devices have been planned and produced to guarantee an optimum performance. In order to keep the high quality level and the long reliability of the Rasor® products, it is recommended using only original spare parts and to contact the head office for any maintenance work.

## 1. GENERAL SAFETY RULES



This manual is an integral part of cutting unit SW12SM and must be carefully read before using it since it gives important indications with regards to its safe installation, use and maintenance. Keep it with care.



Before using cutting unit SW12SM, read carefully the following general safety rules.

EN  
19

- **PACKAGING.**  
After taking off the packaging make sure that the cutting unit is intact. In case of doubt do not use it and contact an authorized service centre. Do not leave pieces of packaging (plastic bags, foam polystyrene, boxes, etc.) within the reach of children or disabled persons since they are potential sources of danger.
- **AVOID DANGEROUS ENVIRONMENTS.**  
Prevent the cutting unit SW12SM components from coming in contact with damp or wet surfaces.
- **KEEP CHILDREN AWAY.**  
Unauthorized persons, in particular children, must be kept away from the working area.
- **FEED CABLE.**  
Prevent the feed cable from coming in contact with hot objects, pointed surfaces or sharp edges. Never pull the feed cable of the machine. It must never be replaced by the user. If necessary contact professionally qualified staff.
- **KEEP THE WORKING AREA ALWAYS IN ORDER.**  
The workplace must always be kept in order and well lightened; liquids or oil traces must not be present.
- **ALWAYS USE CUTTING UNITS SW12SM PROPERLY.**  
Use the cutting units only to carry out the works they have been designed for; do not use them improperly.
- **OBSERVE THE USE OF THE TOOLS.**  
Do not cut excessively thick materials and always check blade conditions.
- **AVOID ACCIDENTAL STARTINGS.**  
Before connecting cutting unit SW12SM, make sure that everything is installed properly.
- **CLOTHING.**  
Do not use large clothes or accessories that might get stuck in the moving parts.
- **GOGGLES AND PROTECTIVE METAL MESH GLOVES.**  
Always use goggles, protective metal mesh gloves approved by Rasor® during use and maintenance operations (according to UNI EN 388:2004 standard).
- **SPARE PARTS.**  
During maintenance and replacement operations use only original spare parts. Blade maintenance must be only performed by Rasor® technicians.
- **INSTALLATION.**  
Any installation that is not in conformity with these specifications could jeopardize your safety and cancels the warranty.



dal 1946

## Informative letter

The installer and the maintenance man must know the content of this manual. Although the main features of the machine described in this manual are not subject to change, **Rasor® Elettromeccanica S.r.l.** reserves the right to modify the components, details and accessories it deems necessary to improve the machine or to meet manufacturing or commercial requirements at any time and without being obliged to update this manual immediately.

EN  
20



**WARNING**



### **ALL RIGHTS ARE RESERVED ACCORDING TO THE INTERNATIONAL COPYRIGHT CONVENTIONS,**

The reproduction of any part of this manual, in any form, is forbidden without the prior written authorization of Rasor® Elettromeccanica S.r.l.

The content of this guide can be modified without prior notice. Great care has been taken in collecting and checking the documentation contained in this manual to make it as complete and comprehensible as possible.

Nothing contained in this manual can be considered as a warranty, either expressed or implied - including, not in a restrictive way, the suitability warranty for any special purpose. Nothing contained in this manual can be interpreted as a modification or confirmation of the terms of any purchase contract.

Rasor® Elettromeccanica S.r.l. machines have not been conceived to work in areas at risk of explosions and at high risk of fire and they cannot cut wet or damp materials. Moreover, they cannot work in case of rain.

In case of damage or malfunction, cutting unit SW12SM must not be used until the Customer Care Technical Service has repaired them.

### **Customer Care Technical Service**



dal 1946

For any information, please contact  
RASOR® ELETTRMECCANICA S.r.l.  
Via V. Caldesi, 6; 20161, MILANO (MI) - ITALY  
Tel: +39.02.66221231; Fax: +39.02.66221293  
e-mail: [info@rasor-cutters.com](mailto:info@rasor-cutters.com)  
web: [www.rasor-cutters.com](http://www.rasor-cutters.com)

**WARNING**



The original configuration of the cutting unit must not be changed at all. On receiving the machine make sure the supply corresponds to what has been ordered. In case of non-compliance immediately inform Rasor®. Also make sure the cutting unit has not been damaged during transport.



dal 1946

## 2. TRANSPORT AND PACKAGING

The cutting unit is delivered in a suitcase, inside which there are various options. The code of the ordered product and its serial number are indicated outside the package (see picture 1). The following accessories are contained in a bag inside the package:

- 1) Polygonal blade;
- 2) Wrench for blade nut disassembly.
- 3) Shuko cable without plug;
- 4) Drift for blade disassembly.

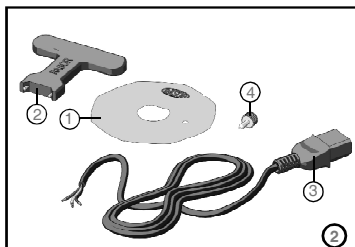
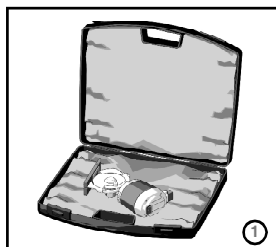

## 3. PLATE DATA

The manufacturer's identification and EC STANDARD 2006/42/EC conformity plate (see picture below) is located on the front part of the cutting unit.

**The plate must not be removed at all, even if the machine is resold. Always refer to the serial number written on the plate itself when contacting the manufacturer.**

Several safety warnings are printed on a card which is applied to the cutting unit feeding cable; such warnings must be strictly followed by everyone dealing with the machine. **The company is not to be held responsible for damage to property or accidents to people which might occur if the above-mentioned warnings are not observed. In such a case, the operator is the only person responsible.**

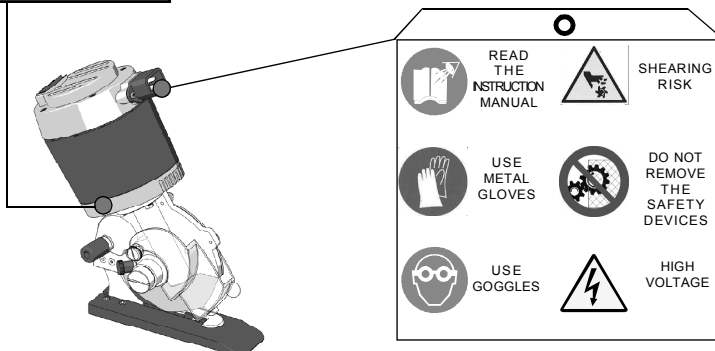

## 4. PRODUCT DESCRIPTION

The fixture described in this manual is a cutting unit model SW12SM which can be assembled on automatic machines (e.g. spreaders, computerized cutting) by means of proper holes located in the motor support.

SW12SM can operate continuously and it can cut at various heights by means of multiple installation. By cutting with the blade and the counterblade always in contact and thanks to the steel upper quality of the blade supplied, SW12SM guarantees the clean separation without fraying of the two borders of the cut material. Thanks to an effective cutting system with polygonal blade, it is possible to use the cutting unit to cut profiles not only in the textile and tannage sector, but also in several industrial sectors such as to cut polymers, thermoacoustic insulators, padding, neoprene, filters, synthetic fabrics and similar fabrics, moquette and internal parts of cars and ships, glass and carbon fibres. The 220V single-phase motor ensures a high blade surface speed (280m/min) enabling cuts with high feed and traverse speed. The blade diameter (120mm) and the motor power (350 Watt) guarantee cuts with thickness up to 5 cm. A sharpener assembled on the cutting unit head allows sharpening the blade at any moment without disassembling it. After carrying out this operation, it is possible to start cutting again. A high power motor, perfectly balanced, with a high number of revolutions and totally free of maintenance, reduces the vibrations to the minimum so that the cutting unit complies with European Directive No. 2002/44/EC concerning the risks deriving from mechanical vibrations. The mechanical parts are made of high resistance steel, bronze and aluminium and require lubrication after several working hours.

EN  
22

Device components			
1	Switch provided with light	7	Movable front protection
2	Motor cover	8	Aluminium platform covered with Teflon®
3	Connector socket	9	Polygonal blade
4	Motor frame	10	Grease nipple
5	Sharpening push button	11	Carbide counterblade
6	Motor support	12	Structure

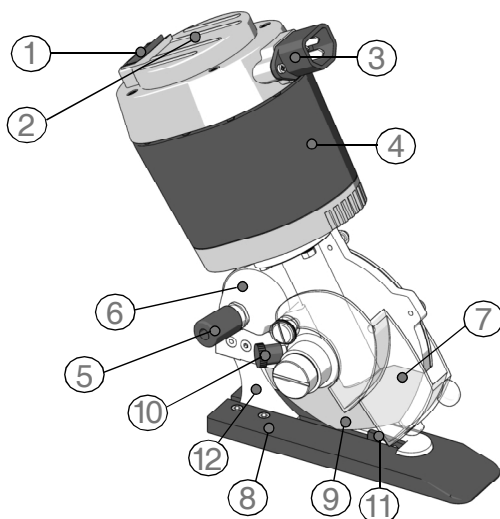

**RASOR**®

dal 1946

## 5. TECHNICAL FEATURES

SW12SM cutting unit features	
Blade diameter	120 mm with hard metal counterblade
Blade speed	550 rev./min
Cutting working depth	about 50 mm
Motor power	Single-phase 220V (110V on request) 350W
Max. absorption	2,5 A
Weight (with feeding cable)	3100 g
Weight (with package)	4000 g
Electric cable length	1,5 mt
Minimum light for working operations	LUX 200
Vibration at the start up	< 2,5 m/s <sup>2</sup>
Working temperature	0 ~ 55°C
Working humidity	10 ~ 95% without condensate

Features of the available blades	
12SHSS	8 side blade Ø 120 mm, in H.S.S. steel
12DHSS	12 side blade Ø 120 mm, in H.S.S. steel
12CSW	Circular blade Ø 120 mm, in Extra steel
12SHSSTN	8 side blade Ø 120 mm, in H.S.S. steel covered with TIN
12DHSSTN	12 side blade Ø 120 mm, in H.S.S. steel covered with TIN
12SMD	8 side blade Ø 120 mm, in integral hard metal
12SHSSTF	8 side blade Ø 120 mm, in H.S.S. steel covered with Teflon®

EN  
23

The technical data are only indicative and they can be changed without notice.

## 6. NOISE LEVEL

The maximum acoustic pressure level emitted by cutting unit SW12SM is about 60 dB (A). Noise tests have been carried out in compliance with Standard UNI EN ISO 11202:2010. The device noise levels, measured at different distances (without any sound wave filtering system), vary in the extent of few db (A).

### NOTE

It is advisable for cutting unit SW12SM owners to verify the compliance with the standard concerning safety of workers: Italian legislative decree 81/08.

## 7. FIELD OF APPLICATION

Cutting unit SW12SM has been designed, manufactured and assembled to cut any kind of fabrics or materials, with the exception of metal, plastic or wood, by means of rotary polygonal blades. This equipment must not work:

- in areas prone to explosions;
- in presence of fine dust or corrosive gases;
- on wet or damp materials;
- to cut plastic, metal and wooden materials.

**It is forbidden to use cutting unit SW12SM for purposes different from the above-mentioned ones.**



dal 1946

## 8. USE WARNINGS

We recommend following the indications below in order to always work in safety conditions.

- All the operations must be carried out complying strictly with the safety rules of the country where the device is to be installed.
- It is STRICTLY FORBIDDEN to smoke during the installation or adjustment operations of the cutting unit.
- The Customer undertakes to comply with and make his staff observe all the rules and regulations in force concerning safety, prevention of accidents and health in the work place. Therefore, the Customer assumes the responsibility to strictly follow all the rules and regulations in force, as well as the special provisions in force in sport and public installations the Customer declares to know after receiving all the relative necessary information.
- **The cutting unit works also without its safety protective device. This protective device must NEVER be removed.**
- Always check the resistance of the material to be cut and the kind of blade which is being used.
- The Customer shall equip his own personnel with all the individual safety protections for the execution of the works, as well as with the ones which might be prescribed by the Manufacturer due to specific danger conditions of the plant or of the area where the personnel must work.
- Do not make any adjustment while the blade is working or while the electric plug is connected.
- Always pay attention to the electric cable position to prevent it from being cut or damaged by the blade.
- It is allowed to assemble cutting unit SW12SM on machines O.E.M. on condition that their original structure is not modified. Otherwise, the intervention must be certified by Rasor®.

## 9. ELECTRIC CONNECTION

Firstly make sure that the lines are able to feed the cutting unit correctly, in compliance with the safety rules (for the feature required see par. 5).

### WARNING



We suggest installing a magnetothermic safety device before the cutting unit and check that the ground circuit is effective. Before working on the feeding cable pull the plug out. Check that electric connections and protections correspond to the driving force and the plate data values (voltage and current), required by the different electric circuits. Possible faulty ground connections make the working conditions unsafe. Possible damages are not charged to Rasor®. By referring to the EC 11-27/1 standard all the works carried out by means of electric current must be performed by a staff, who has been provided with all the devices required by the above-mentioned standard. For the works carried out under voltage, it is necessary that the employer certifies the suitability, against formative processes. As the cutting unit SW12SM is supplied without plug, the user must use a plug homologated in the country in which the cutting unit is used.

In the European Countries a Shuko plug is required (see picture 3). Never change the length of the cable supplied. The cutting unit SW12SM is a class II electric device, therefore it does not need any grounding cable.

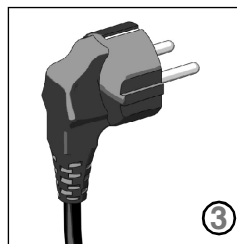



## 10. RESIDUAL RISKS

Even though the cutting unit is safe, operators must pay attention to preserve their and other people's safety.

- ⊗ At the end of the working operations, the metal parts could be very hot.
- ⊗ The cutting blade can work even when the protective device is disassembled.

## 11. INSTALLATION AND USE

To install and use the cutting unit manually, proceed as follows:

- 1) Fix the cutting unit on level squares or angles by means of four 5MA screws, by inserting them in the four holes located in the motor lower cover (see pictures 4 and 5).

### NOTE

The cutting unit can be installed in any position/angle: vertically, laterally and it can be turned upside down. It is not compulsory for the aluminium base to touch the machine table.

- 2) Lay the material to be cut;
- 3) Connect the cutting unit to the electric feeding (see picture 6);
- 4) Put the material on the cutting foot (see picture 7);
- 5) Adjust the front mobile protection according to the thickness of the material to be cut (see picture 7);
- 6) Enable the switch; once it has been enabled, it lights with a green light (see picture 8);
- 7) Carry out the cutting operation.

### NOTE

Cutting unit SW12SM can work in a fixed position (the material has to be moved) or it can move forward while the material is kept in the same position. Make sure the material to be cut is properly stretched, preventing it from curling.

### WARNING

**Never use the two bolts which fix the motor to the cutting part to fasten cutting unit SW12SM. This operation may cause the motor shaft to break. In this case, warranty is not valid.**

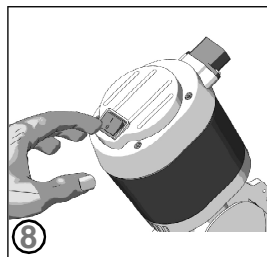
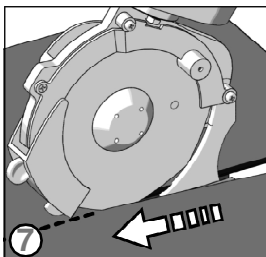
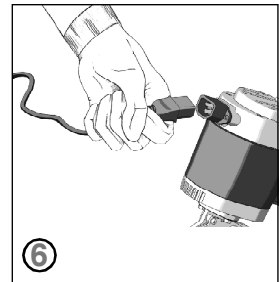
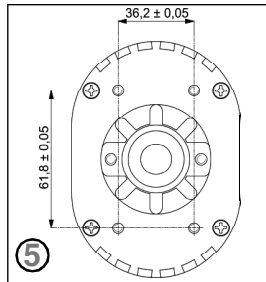
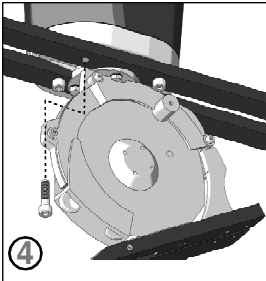

**RASOR**<sup>®</sup>

dal 1946

## 12. BLADE SHARPENING

After many hours of a continuative use of the cutting unit or if it would not be able to cut anymore, it is necessary to sharpen the blade.

To carry out this operation, start the blade and press sharpener "2" located on it 3-4 seconds (by pressing push button "1", as shown in picture 9). Repeat the operation 2-3 times.

If the sharpening operation is not effective, check the wear of emery grinding wheel "3" (see picture 10). If grinding wheel "3" is too worn or dirty, replace it.

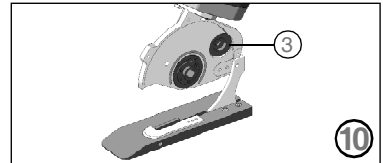
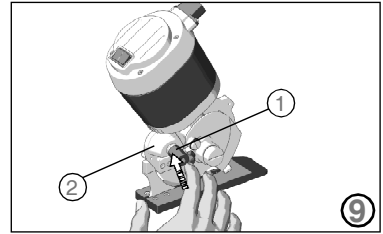

## 13. LUBRICATION

Every 3-4 working days, it is necessary to lubricate the pair of gears. To carry out this operation, remove protective plug "A" located on the motor support of the cutting unit and fill it with lubricating grease Rasor®. Screw plug "A" again few turns. Screw plug "A" some turns every 2-3 working days (see picture 11).



The blade must never be dirty with grease or oil.

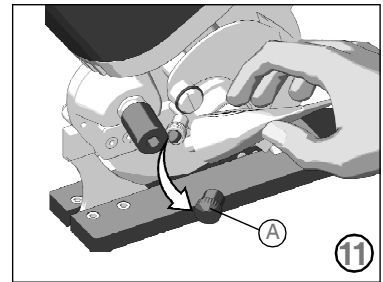

## 14. MOTOR BRUSH REPLACEMENT

Worn motor brushes could create a cutting unit malfunction (no starting, intermittent start, etc.), therefore it should be better to verify their wear periodically.

Open the motor cover by unscrewing 4 screws "4" on the cutting unit head (see picture 12). Remove the metal contacts that close the brushes with a slotted screwdriver (see picture 13). Remove the brushes and check their wear: if the graphite has a length shorter than 15 mm or it is uneven, replace it (see picture 14).

Close the metal contacts again by making sure that they adhere well to the metal part of the brush. Finally close the motor cover again.

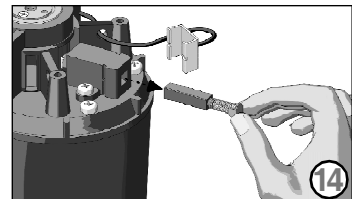
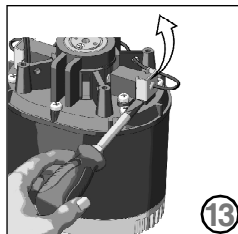
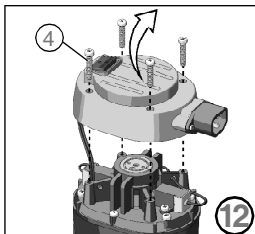

**RASOR**®

dal 1946

## 15. BLADE REPLACEMENT

If the blade is no more able to cut (even after repeating the sharpening operation several times) it is necessary to replace it. To carry out this operation, use butterfly wrench "1" and drift "3" locking the blade (shown in picture 15).

To replace the blade, proceed as follows:

- 1) Use some protective gloves in compliance with Italian Legislative Decree 81/08;
- 2) Remove the fixed rear safety protection "A" (see picture 16) by unscrewing the three cross-slotted screws "C", "D" and "E" by means of the proper screwdriver (not supplied by the manufacturer) as shown in picture 17. Remove the movable front safety protection "B" (see picture 16) by unscrewing pin "F" and the two washers "G" as shown in picture 17.
- 3) Insert drift "3" (see picture 15) into hole "H", so as to lock the blade (the hole on the blade must correspond to the one on the structure).
- 4) Use butterfly wrench "1" to unscrew nut "L" and remove blade "M" (see picture 18).
- 5) Replace the worn blade with the new one "2", being careful to center the blade on the shaft in the correct position; we remind you to assemble it so that the side with the writing Rasor can be seen by the operator.
- 6) Assemble all the components again and carry out the sharpening.

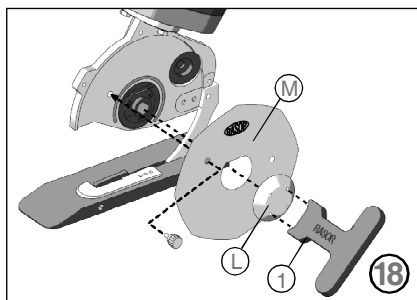
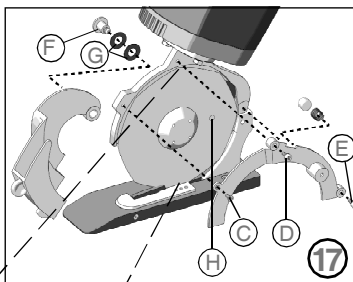
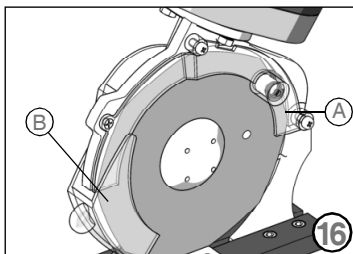
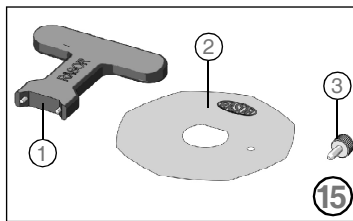

## 16. TROUBLESHOOTING

### ✘ PROBLEM

### ⇒ SOLUTION

EN  
28

The material is not cut or it gets stuck between the blade and the counterblade	Make sure that the blade touches the counterblade
	Check the kind of material
	Sharpen the blade
	Check the material thickness
	Check the compatibility between blade and material
The cutting unit is noisy	Make sure that the motor turns correctly
	Reduce the feeding speed
	Check the counterblade integrity
	Carry out the lubrication
The cutting unit starts slowly, works intermittently or it does not start	Disassemble the blade and remove the material residues
	Check the wear of the pair of gears
	Check the electric connections on the O.E.M. unit
	Check the electric connections
	Check the motor brushes
	Check the feeding cable

## 17. SPARE PARTS / EXPLODED VIEW

CODE	DESCRIPTION	CODE	DESCRIPTION	CODE	DESCRIPTION	CODE	DESCRIPTION
12SHSS	8 SIDE BLADE Ø 120 mm, IN H.S.S. STEEL	SW121000	MOTOR BEARING L9	SW1244CL	FRONT PROTECTION SET	T 100300	ADJUSTING SCREW LOCKING SCREW
SW10225	MOTOR FRAME WITH MAGNETS, WITHOUT HANDLE	SW121200	ANTI-GREASE WASHER	SW1255M	COMPLETE MOTOR SUPPORT	T 100600	MOTOR BRUSHES
SW10295	ELECTRONIC FEEDING CIRCUIT	SW121301P	COMPLETE ROTOR 110 V	SW125600	SUB-BLADE RING	T 100700	BRUSH HOLDER
SW10375	FEEDING CIRCUIT FASTENING SCREW	SW1213P	COMPLETE ROTOR 220 V	SW126101	BLADEGUIDE PIN	T 100800	BRUSH HOLDER CLIP
SW104102	OILER RING	SW121500	FAN	SW126102	REFERENCE PIN	T 100900	BRUSH HOLDER FIXING SCREW
SW104103	OILER RING SPRING	SW121600	MOTOR BEARING L12	SW126103	GEAR RING FIXING SCREW 2,5MA	T 101801	ELASTIC PIN
SW10765	SPRING WITH DOWEL	SW121700	ELASTIC RING	SW126201-1P	GEAR RING	T 102001	UPPER CAP FIXING SCREW
SW107900	SCREW FOR THE COUNTERBLADE HOLDER FIXING	SW121800-1P	WORM SCREW	SW126300	RING NUT FIXING THE BLADE	T 102100	LOWER CAP FIXING SCREW
SW108000	COUNTERBLADE HOLDER	SW121801CP L-1P	COMPLETE PAIR OF GEAR	SW127201	BEARING R6 GEARS	T 102201	PAIR OF PERMANENT MAGNETS
SW108100	HARD METAL COUNTERBLADE	SW12195	LOWER MOTOR CAP	SW127500	GEAR BEARING ADJUSTING DEVICE	T 102702	SOCKET SCREW - THREE POLES
SW108200	COUNTERBLADE FIXING SCREW	SW122000	UPPER MOTOR CAP	SW127501	ADJUSTING DEVICE FIXING DOWEL	T 1027CPL	FEEDING CABLE WITHOUT PIN
SW108700	SHARPENER PIN	SW123800	STEEL STRUCTURE Monster series	SW127502	WASHER	T 102904L	CAP SWITCH WITH LIGHT
SW108800	EMERY SPRING Ø 11 mm	SW123900	STRUCTURE FIXING SCREW	SW127600	CLOSING CAP	T 104501	CONVEX WASHER
SW108900	SHARPENER BUSH	SW124000	STRUCTURE SUPPORT SCREW	SW128600	MEDIUM GRAIN EMERY Ø 30x10x6	T 104700	GREASER CAP
SW109000	EMERY SPRING Ø 6 mm	SW124100	FIX REAR PROTECTION	SW1286CPL	COMPLETE EMERY UNIT	T 104800	GREASER
SW109100	SHARPENER CAP WITH BEARING	SW124101	3x10 MA SCREW REAR GUARD FIXING	SW1290M	RIGHT BASE WITH BEVEL Monster	T 105200	MOTOR SUPPORT FIXING BOLT
SW109200	SCREW FOR SHARPENER CAP FIXING	SW124102	3x5 MA SCREW REAR GUARD FIXING	SW1290MCPL	COMPLETE RIGHT BASE WITH BEVEL Monster	T 105300	WASHER
SW109300	WASHER	SW1241CPL	REAR PROTECTION SET	T 100102	MOTOR COVER	T 105400	ANTI-FRICTION BUSH
SW120400	MOTOR BEARING ADJUSTING SCREW	SW124400	FRONT PROTECTION GUARD	T 100200	MOTOR COVER FIXING SCREW	T 107500	BLADE ASSEMBLING/DISASSEMBLING WRENCH
SW120500	CORRUGATED THRUST BEARING PAIR	SW124402	FRONT PROTECTION FIXING SCREW	T 100201	SOCKET SCREW	T 107600	DRIFT LOCKING THE BLADE
						T 107900	LUBRICATING GREASE



dal 1946



---

## WARRANTY

Rasor® Elettromeccanica S.r.l. cutting unit has a 12 month warranty from the date indicated on the last page of this manual, except in case of different written agreements.

The warranty covers all manufacturing and material defects. Replacement and repair operations are covered only if carried out by our company and at our workshop. If in-warranty goods need to be repaired, **the customer must always send the complete machine to Rasor®. Single units will not be repaired under warranty.**

The material to be repaired must be sent CARRIAGE FREE.

Once the machine has been repaired, it will be sent CARRIAGE FORWARD to the customer.

The warranty covers neither technicians' intervention on site nor the machine disassembly from the installation place.

If for practical reasons, one of our technicians is sent to the premises, the customer will be charged the costs plus the travelling expenses.

The warranty does not include:

- ✎ failure caused by wrong use or assembly,
- ✎ failure caused by external agents,
- ✎ failure caused by lack of maintenance or negligence;
- ✎ blades and parts subject to wear.

WARRANTY FORFEITURE:

- ✎ In case of arrearage or other breaches of contract,
- ✎ Whenever changes or repairs are carried out on our cutting units without our prior authorization,
- ✎ Whenever the serial number is tampered with or cancelled,
- ✎ Whenever the damage is caused by improper use, bad treatment, bumps, falls and other causes not due to normal working conditions,
- ✎ Whenever the unit seems tampered with, dismantled or previously repaired by unauthorized staff,
- ✎ In case the cutting units are used for purposes that are different from the ones described in this manual.
- ✎ In case non-original spare parts are used.

All repair operations carried out under warranty do not interrupt its duration.

**All disputes will be settled in the court of justice of Milan (Italy).**

We thank you in advance for the attention you will pay to this manual and we invite you to inform us of any change you deem necessary to improve it and make it more complete.

---

DECLARATION OF CONFORMITY



We hereby certify that the device specified hereunder complies to the requirements of Machinery Directive 2006/42/EC, Electromagnetic Compatibility 2004/108/EC and CEI EN 60204-1, Directive 2002/44/EC and to technical rulings UNI EN 414:2002, UNI EN ISO 12100:2010.

Noise tests have been carried out according to UNI EN ISO 11202:2010 Standards.

Cutting unit SW12SM has been produced according to workmanlike standards.

We declare that the above-mentioned goods comply with the standards in force concerning safety and hygiene at work that can be applied to the material itself according to the Italian legislative decree No. 81/08 (local law); the above-mentioned goods are not included in the goods indicated in annex IV of Machinery Directive 2006/42/EC.

- 1. Category: **ELECTRIC CUTTING UNIT**
- 2. Manufacturer: **RASOR®ELETTROMECCANICA S.R.L.**
- 3. Type: **SW12SM**
- 4. Serial number: .....
- 5. Year of manufacture: .....
- 6. Country of manufacture: **ITALY**
- 7. Additional information: .....

Warranty expiry:  
12 months invoice date or receipt

**RASOR ELETTROMECCANICA S.R.L.**  
*CUTTING EQUIPMENTS*

  
\_\_\_\_\_  
(Signature)



